

Between Students

Klara Schmitt



Between Students

Creative Brief	3
Navigation Map	8
Database Schema	9
Flow Chart.....	10
Wireframes	11
Design Comps	17
Credits	22

Between Students

Title: Between Students - Textbook Swap

Purpose: To provide a website that allows students to search through listings posted by other students regarding selling or swapping of textbooks required by various classes at any number of colleges in the DC Metropolitan area. Students will be able to contact one another about buying, swapping, or borrowing of textbooks, thus saving them money by removing the middleman.

Perception Tone: Familiar

Audience: College students in the DC Metropolitan area who need textbooks or are selling textbooks and would like to recoup costs.

Between Students

Audience Profile #1:



Name: lyisha Steerway
Age: 18
Major: Interior Design
Quarter: Third

lyisha is a commuter student attending the Art Institute of Washington for a Bachelor's degree in Interior Design. Subsequently, she must take a number of general education classes to earn her degree. She is presently finishing up her third quarter, in which she has two design classes directly related to her major, and two general education classes. While lyisha intends to hold onto textbooks relating to her major, she would like to sell the other two books which she had to buy for her Psychology and Public Speaking classes. She bought all of her books in the student store, but when she brings them to sell back, she is only offered a fraction of what she paid to buy them. lyisha knows that there have to be other students who need these books for the next quarter and that if she just sells them for ten dollars cheaper than the bookstore, she'd make back about the same she paid for them, and the other student would get a discount. She just simply does not know how to reach these students.

Then one day while she's heating up her dinner in the student lounge she notices some papers scattered on top of one of the tables – it's a short message about a new database called Between Students for swapping books within the school. lyisha pockets the paper for later and heads into the hallway to eat her dinner. Sure enough, when lyisha has a chance to visit the site, it's pretty much what she needs – it's free and less formal than using Amazon.

Between Students

Audience Profile #2:



Name: Brian Fogarty

Age: 24

Major: Web Design & Interactive Media

Quarter: Seventh

Brian is pursuing an Associate's degree in Web Design from his community college and has to take three art history classes for his degree. He's already taken the two that require the massive and expensive textbook, but he now has to take Contemporary Art. He's only one quarter away from graduating and he really doesn't want to have to buy any textbooks that aren't part of his program; he's a little tight on money right now. He starts asking around to see if anyone has a copy of the Contemporary Art book he can borrow, but none of his buddies have it. However, one friend mentions a website created by a web design student for sharing textbooks. Brian hunts it down and while the users on the website primarily seem to be selling and buying textbooks, he finds a graphic design student who is willing to swap it for either the English Lit textbook or the Ethics text. Brian just took Ethics last quarter and hasn't yet sold it back to the bookstore, so he quickly contacts the person about a swap.

Between Students

Content:

1. Home – The home page explains what Between Students is and what steps one needs to take to join.
2. User Agreement – This page would list the services that Between Students offers as well as a disclaimer that Between Students isn't liable for any exchanges that go amiss between students.
3. Book Listings – This page would be a listing of classified ads and would be ordered by newest date posted. This page also has a sidebar with FAQ.
4. Post New Listing – This page would allow a registered user to create a classified ad with the following information fields.
 - User name
 - Book Title
 - Book Author
 - Class number
 - Class name
 - Teacher name
 - ISBN number
 - Edition
 - Book Condition
 - Option: [swapping] or [selling] or [giving]
 - Date Posted
5. Sign Up – This page would require the information below before the user can post listings. Anyone can view listings, but they will not be able to post their own listings or see others' email addresses without being logged in first.
 - User name
 - Password
 - Email Address
6. Change Your Password – This page allows users to change their password if they wish.

Between Students

Navigation Map:

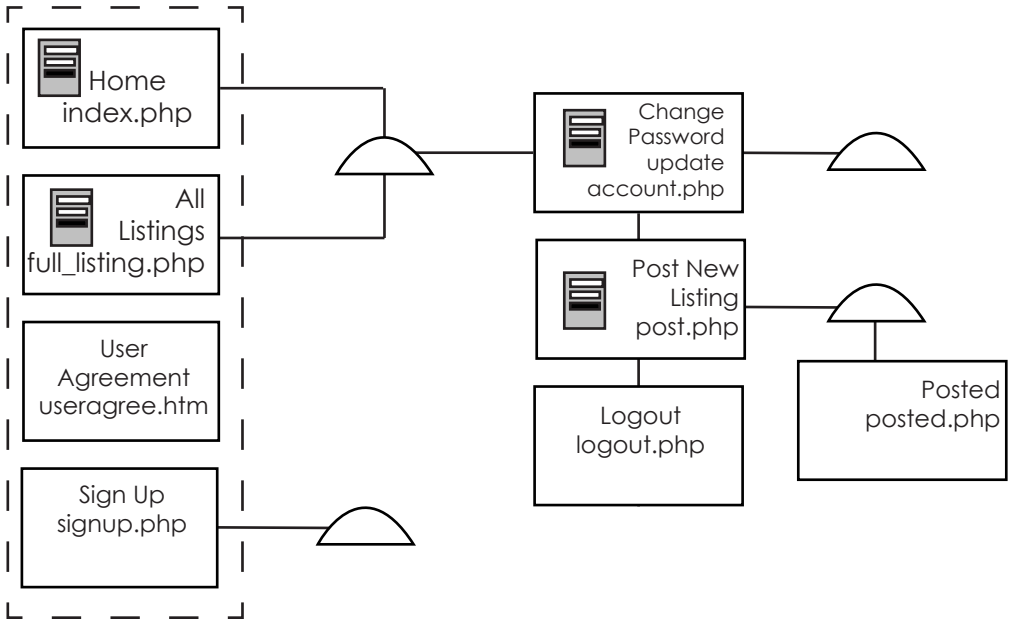

Key

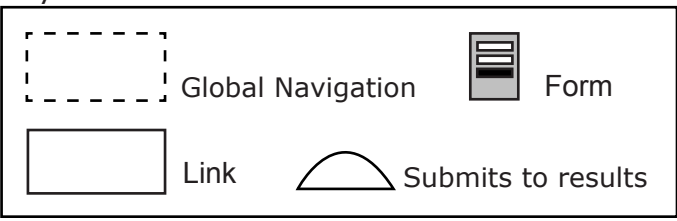

Between Students

Relational Database:

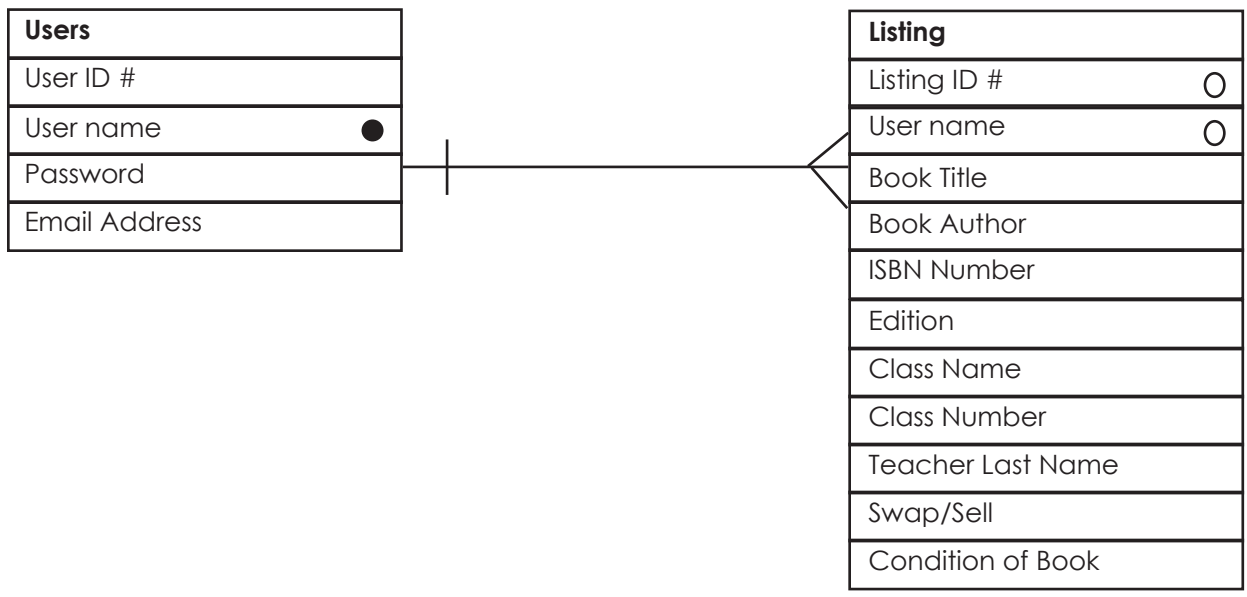

Key

- Primary Key
- Foreign Key
- ⌞ One-to-Many
- ⌞⌞ One-to-One

Between Students

Contacting a User:

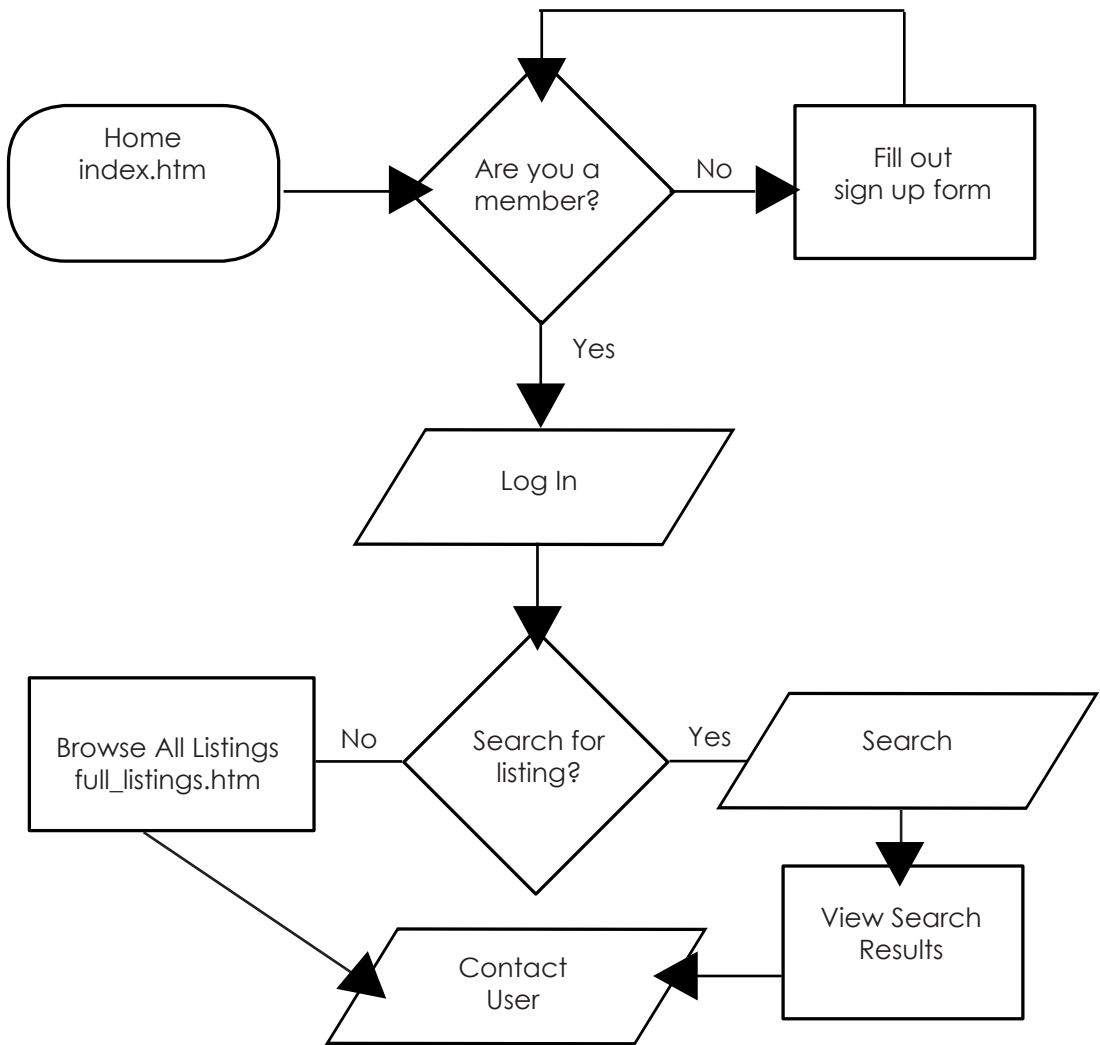

Between Students

980 px

Home:

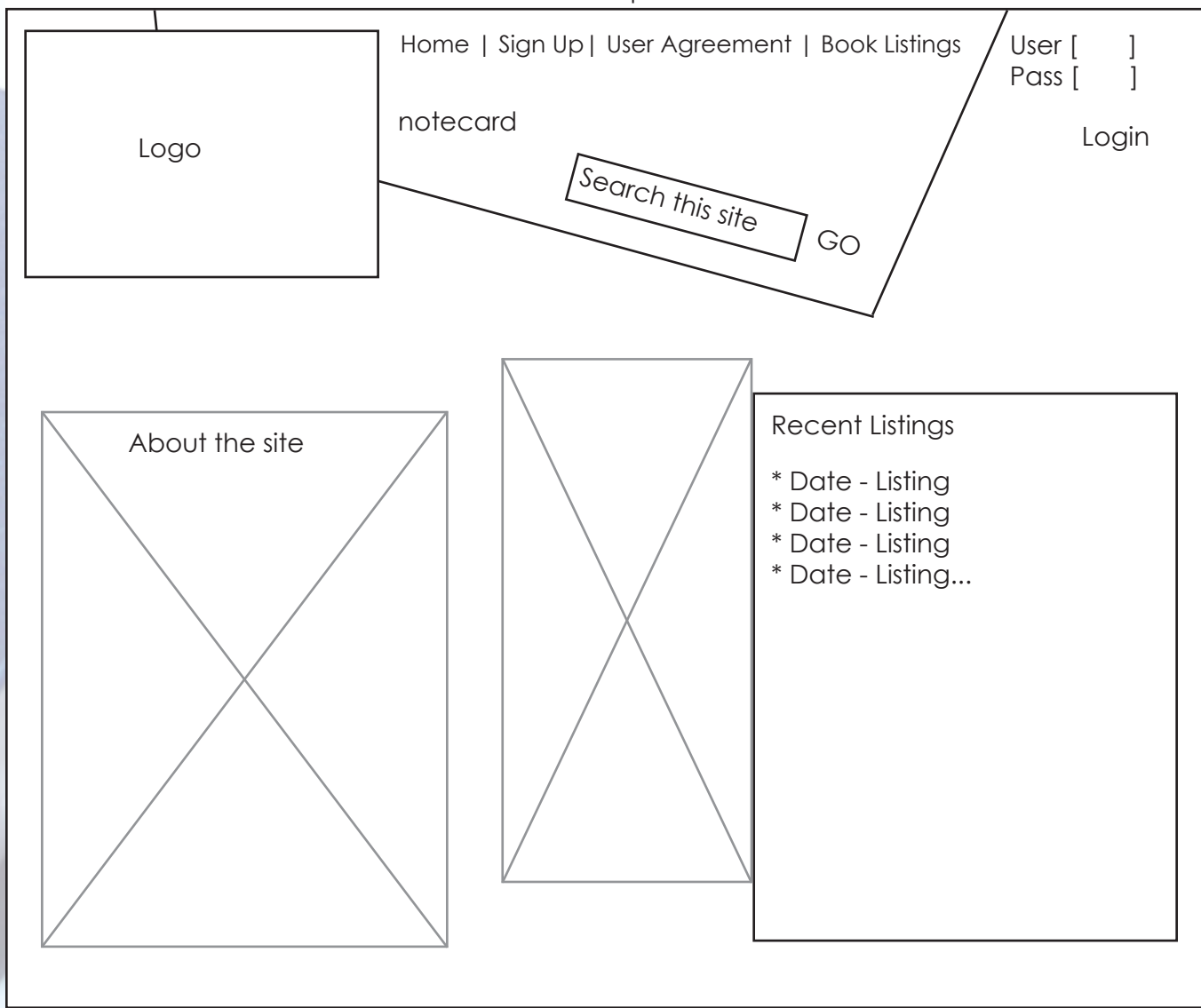

Between Students

980 px

User Agreement:

The wireframe shows a website layout with a 980px width. At the top, there is a navigation bar with links: Home | Sign Up | User Agreement | Book Listings. On the right side of the navigation bar, there are input fields for 'User []' and 'Pass []', followed by a 'Login' button. Below the navigation bar, there is a 'notecard' area containing a search bar with the text 'Search this site' and a 'GO' button. To the left of the search bar is a 'Logo' placeholder. Below the search bar, there is a large rectangular area containing the 'User Agreement' text. The text includes a section titled 'Usability' and another titled 'Prohibited Content'. A vertical double-headed arrow on the right side of the wireframe is labeled 'scroll', indicating that the content in the main area is scrollable.

Home | Sign Up | User Agreement | Book Listings

User []
Pass []

Login

notecard

Logo

Search this site GO

User Agreement

Usability
By accessing this website (including all material contained therein), you declare your consent to the following terms and conditions. You also agree that you are at least 14 years old or have your parent's permission to be on this site.

Between Students is a classified ads site primarily for students of the art college located in Rosslyn. Between Students' purpose is to give students a way to buy and sell textbooks from one another by allowing them to post listings of what they have as available. However, Between Students does not accept any responsibility for enforcing payment between individuals and all transactions must be performed outside of this website. Between Students is simply the medium for connecting individuals.

Prohibited Content
By joining Between Students, you agree that you will not post any material that is:

Between Students

980 px

All Listings (View Only):

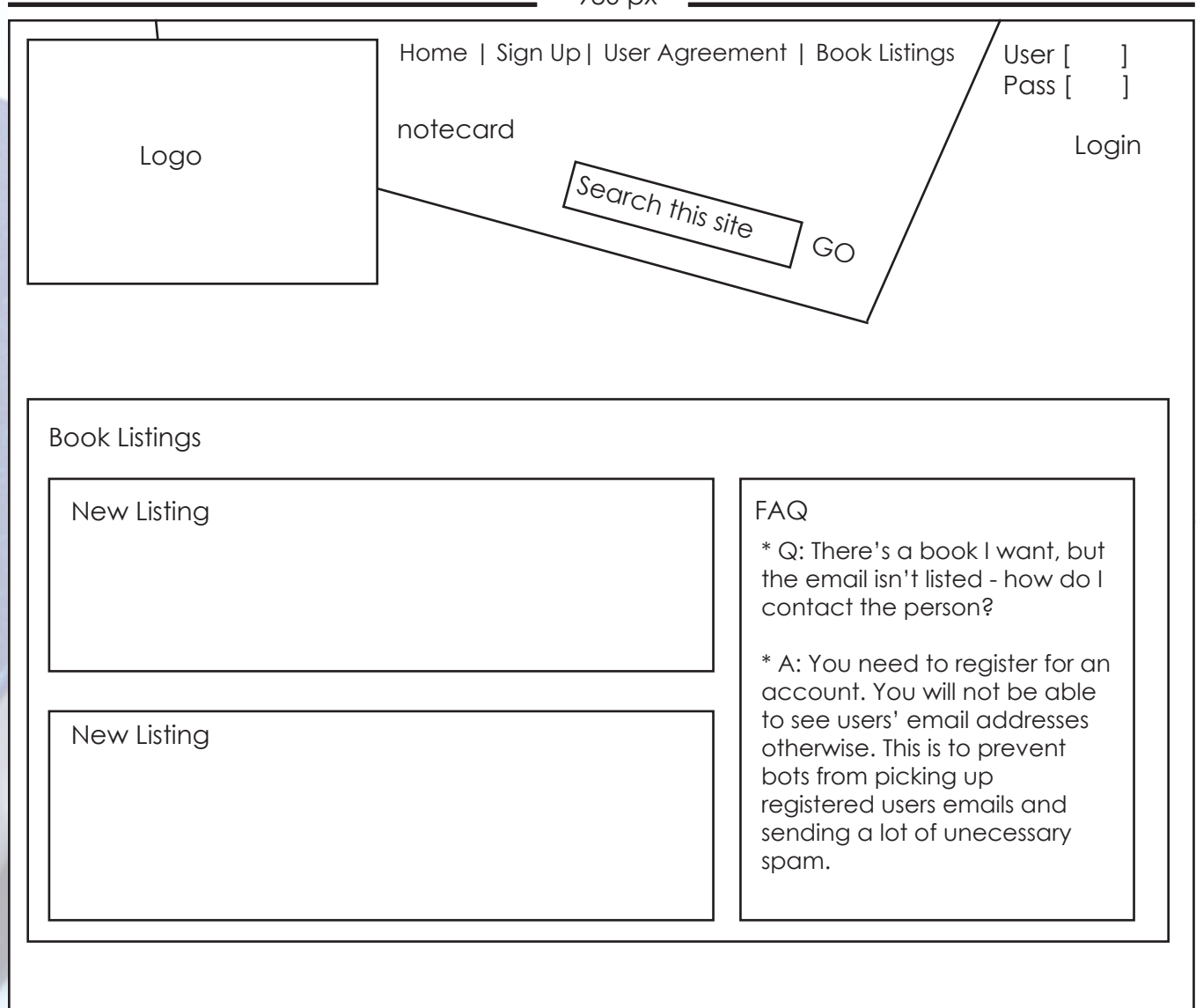

Between Students

980 px

All Listings (Logged In):

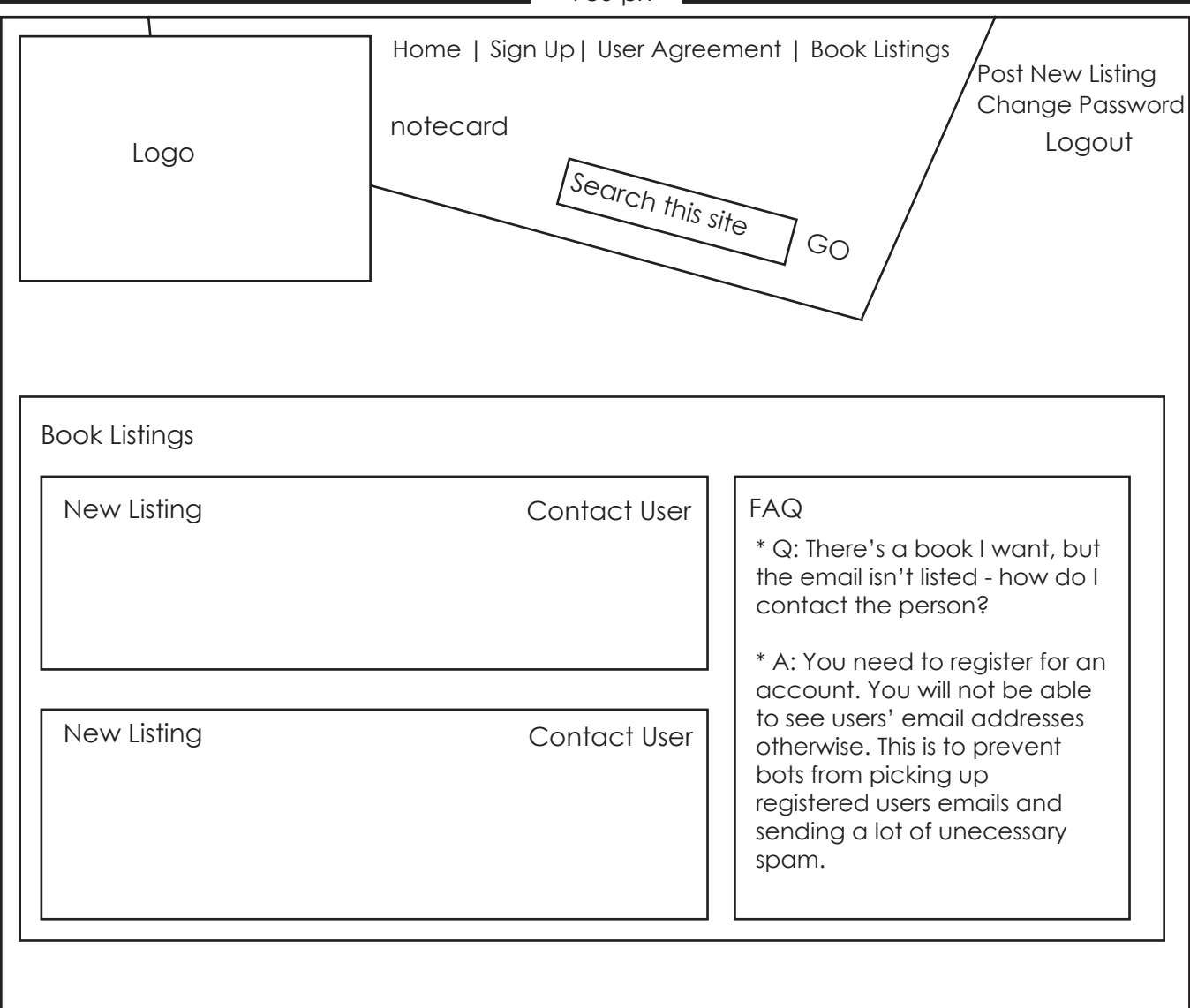

Between Students

980 px

Sign Up:

The wireframe shows a page layout with a navigation bar at the top containing 'Home | Sign Up | User Agreement | Book Listings'. On the right side of the navigation bar are 'User []' and 'Pass []' fields, and a 'Login' button. A search bar is located below the navigation, containing the text 'Search this site' and a 'GO' button. A 'notecard' is positioned to the left of the search bar. A 'Logo' box is on the far left. Below the navigation and search area is a large 'Sign Up' form containing three input fields: 'Username', 'Password', and 'Email Address'. A vertical double-headed arrow on the right side of the page is labeled 'scroll', indicating the scrollable content area.

Between Students

980 px

Post New Listing:

Home | Sign Up | User Agreement | Book Listings

notecard

Search this site GO

Post New Listing
Change Password
Logout

Post New Listing

User name
Book Title
Book Author
ISBN Number
Edition
Class Name
Class Number
Teacher Last Name
Swap/Sell
Condition of Book

scroll

Between Students

980 px

Change Password:

Home | Sign Up | User Agreement | Book Listings

Logo

notecard

Search this site GO

Post New Listing
Change Password
Logout

Change Password

User Name
Email Address
Old Password
New Password
New Password Again

scroll

Between Students

Home Page:

Home | User Agreement | Sign Up | Book Listings

Willing to sell Spanish 101 textbook for Dr. Ruez class for \$70. Email if interested.

Please enter search

User
Pass

#717
Ca
W

17

Login

Generosity
[jen-uh-ros-i-tee]
noun, act of giving freely

One of life's little **pleasures**. Makes you happy and someone else **ecstatic**. Especially if it's books you're **giving** away.

So if you could **bring us bagloads of books**, we'd be over the moon.

But be quick. We've got a big event coming up that will involve stacks of books and a whole lot of **fun**.

Recent Listings

- Title: **Storm Duty**
Posted on: September 30, 2010 4:16 PM
- Title: **Web Design 101**
Posted on: December 16, 2009 11:12 AM
- Title: **Room 807 is Freezing**
Posted on: December 12, 2009 11:11 AM
- Title: **Eastern Coast Dinner Dates**
Posted on: December 12, 2009 11:09 AM
- Title: **Baking and Pastry Advanced**
Posted on: December 09, 2009 1:33 PM
- Title: **Good dogs**

Between Students

Book Listings:

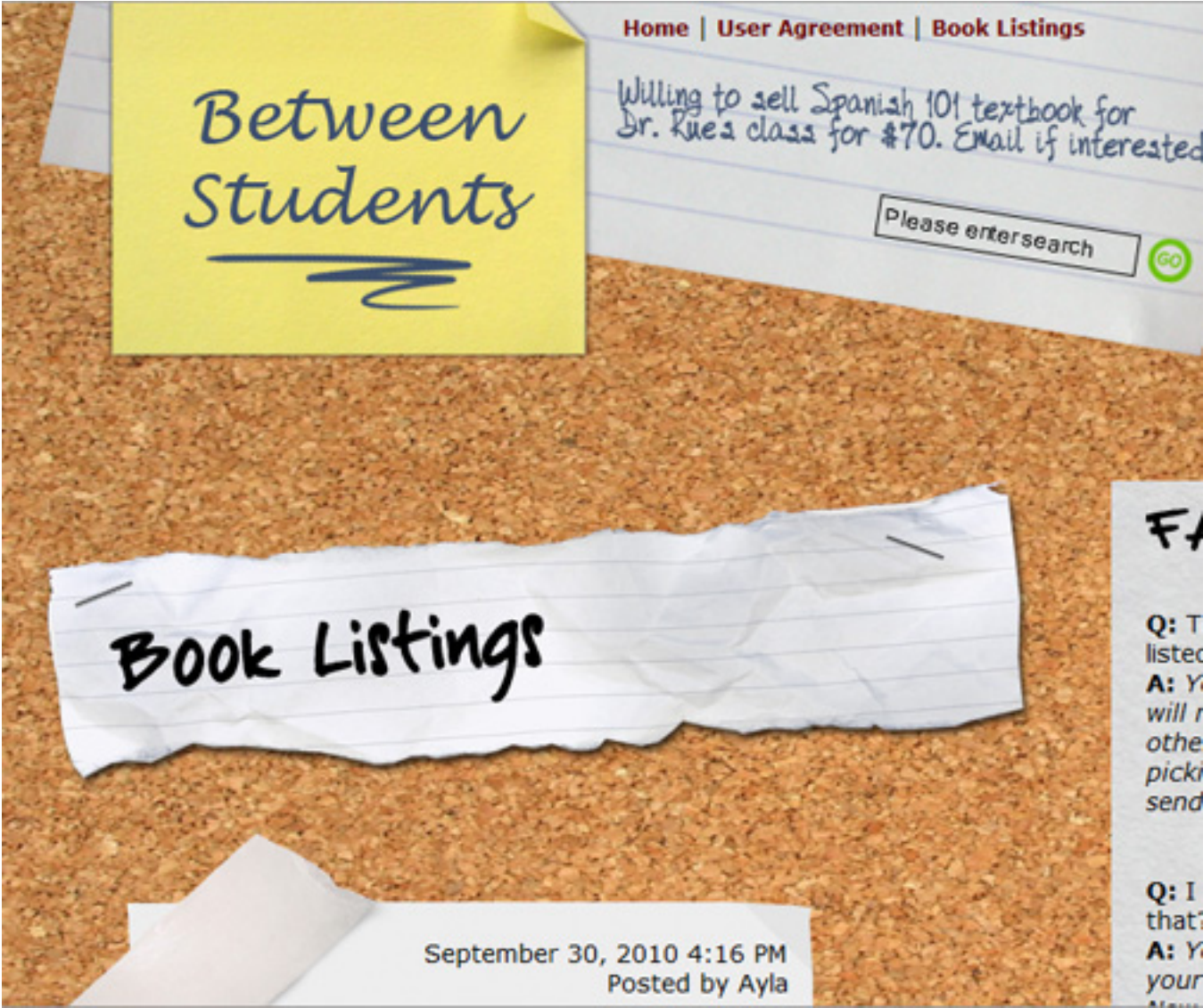

Between Students

Post a Listing:



Post a Listing

Book Title:

Author's Name:

ISBN:

Edition:

Class Name:

Class Number (ie. ART224):

Teacher's Last Name:

Book Condition: Action:

[Post Listing](#) [Clear Form](#)

Between Students

Input Boxes:
Sign Up
Change Password
Access Denied
Sign Up Complete

Change Your Password

Do you need to change your password?
Just fill out the form.

Username:

Current Password:

New Password:

Retype New Password:

[Update Account](#) [Clear](#)

Between Students

User Agreement:

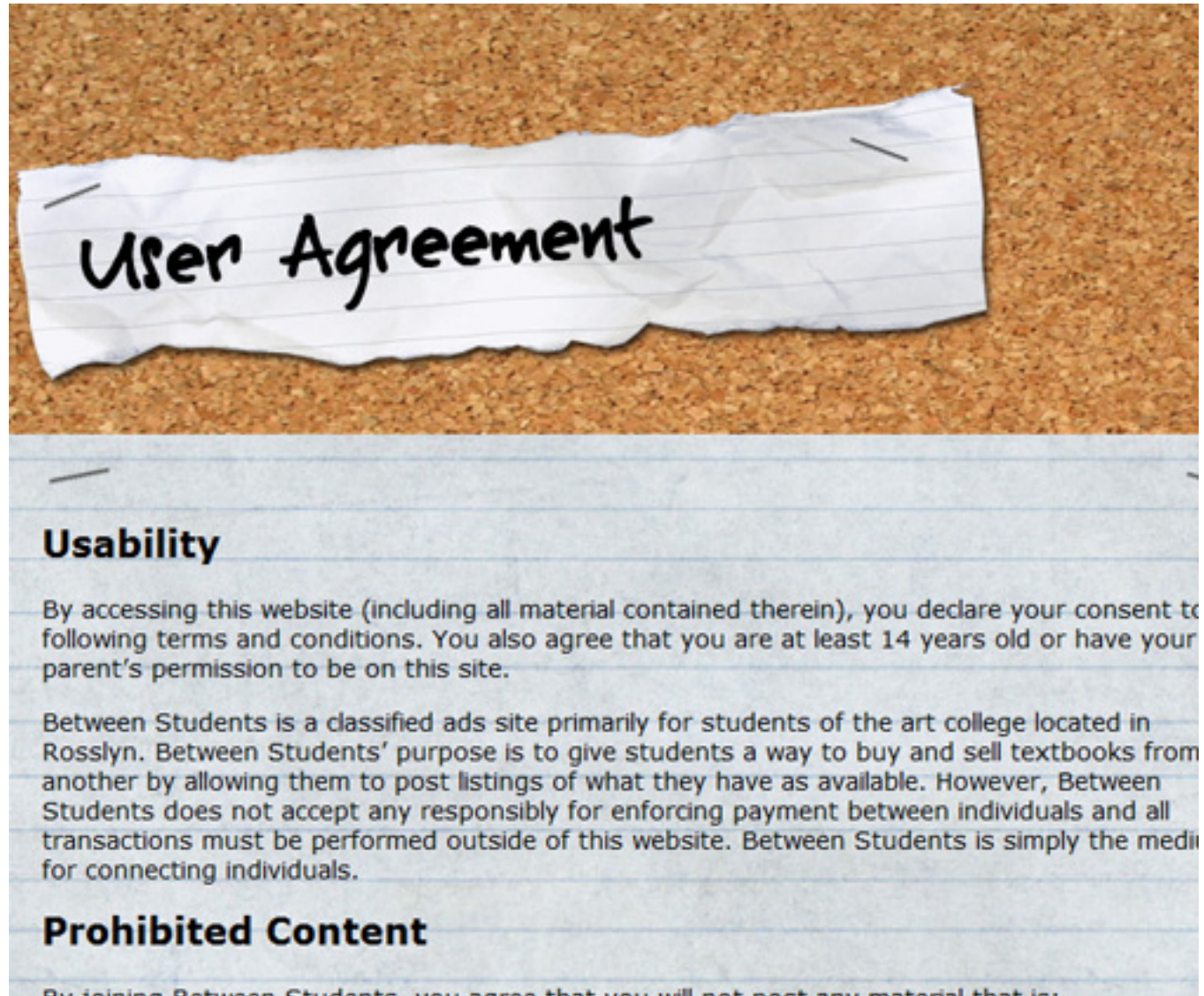

Between Students

Process Book Credits:

Brainshake. Office equipment. 26 January 2006. Stock.xchng. Retrieved on 13 December 2009 from <<http://www.sxc.hu/photo/454485>>.

Northcut, Thomas. Girl (8-10) holding gift and kissing young woman on cheek. GettyImages.com. Retrieved on 13 December 2009 from <<http://www.gettyimages.com/detail/200451532-001/Digital-Vision>>.

Stafford, Siri. Businessman standing in hallway of office, smiling. GettyImages.com. Retrieved on 13 December 2009 from <<http://www.gettyimages.com/detail/200488045-001/Digital-Vision>>.